

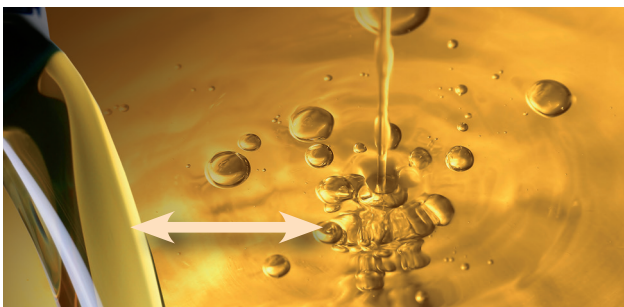

## DIESEL SWITCH

Change over or blending  
Fuel management without  
compromise.

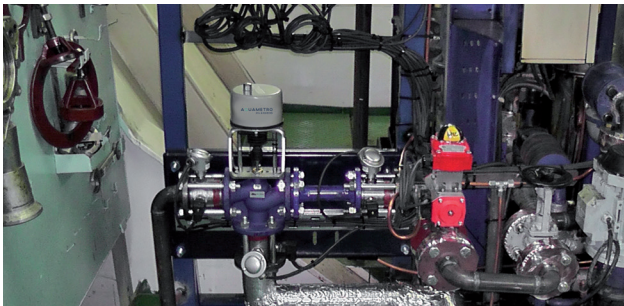

The DIESEL SWITCH is a fuel management system which helps you to comply with MARPOL regulation. It controls fully automatically the changeover and blending process on board your good vessels and will manage additional processes within your fuel system. Protect your engine - no human risk! Save ship operation - change over or blending process in maneuvering area's.

### Features

- Simplest and universal design / turn key product
- Automatic fuel change over or permanently controlled fuel blending
- Full DNVGL type approval certificate
- Saving fuel costs
- Control temperature rise - fuel on engine
- Full data visualization and storage
- Additional GPS-position available

### Benefits

- Fast and safe fuel switching under normal ship operation conditions
- Continuous blending possible to save expensive diesel fuel
- High ship availability and safety in maneuvering area's
- Complies with MARPOL regulations
- Easy installation / short downtime
- Prevent thermal damage on engine

## Worldwide emission control areas (ECA)

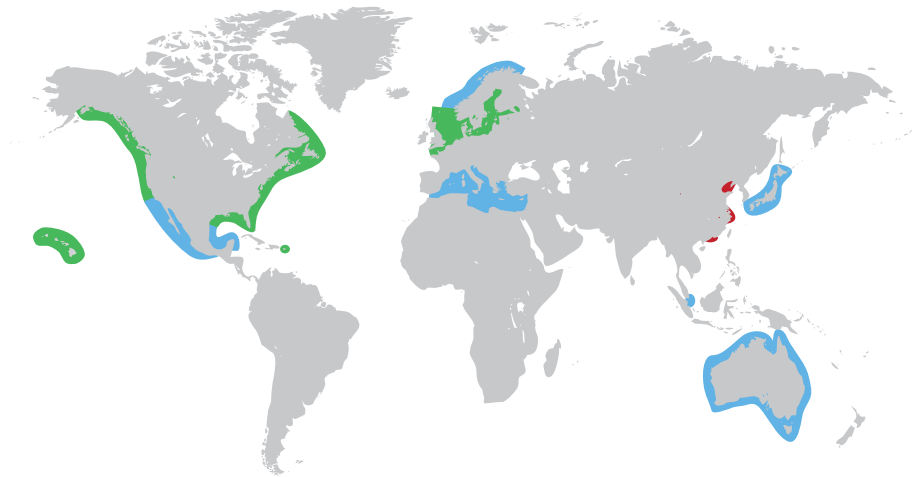

Planned ECA's with different fuel quality:

- Mediterranean Sea
- Coasts of Mexico
- Tokyo Bay
- Singapore
- Korea
- Australia
- Black Sea
- Arctic
- Antarctica

SOx Emission Control Areas (ECAs)

- Existing ECA area
- Potential future ECA area
- China ECA area

## Timeline for sulphur limitations in fuel oil

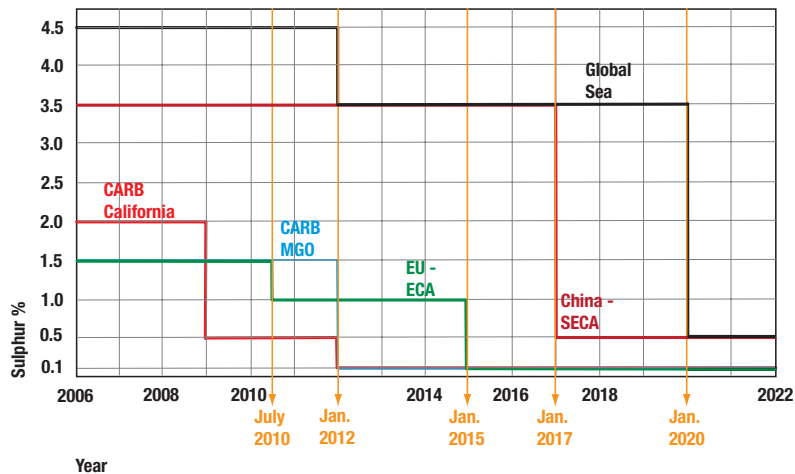

MARPOL ANNEX VI Regulation 14 and Regulation 18

EU Directive 1999/32/EC and 2005/33/EC for Baltic and North Sea ECA

CARB - California Air Resources Board - Regulation 13 CCR §2299.2(e) and 17 CCR § 93118.2(e)

SECA National Regulation China Ministry of Transport 2106

## System Application Layout

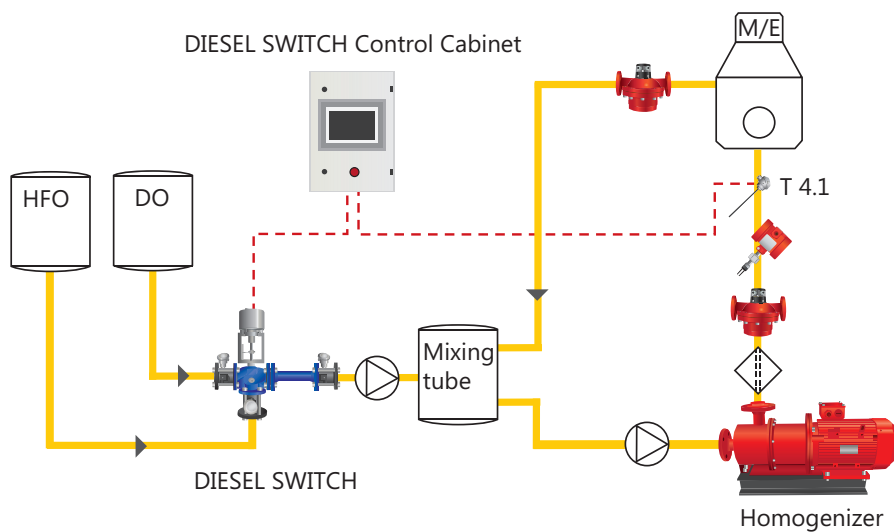

## Technical benefits

### Manual change over valve

- ! Risk of incidents due to uncontrolled change over
- ! Risk of damages in fuel system due to temperature shocks

### DIESEL SWITCH

- ✓ Automatic and safe change over unit with safety functions
- ✓ No risk of incidents
- ✓ Improved temperature separation of fuel systems
- ✓ Class approved change over or blending procedure
- ✓ Simple and universal design - easy installation
- ✓ Automated, permanently controlled fuel blending
- ✓ Viscosity monitoring with alarm function

## Saving potential considering fuel oil blending

### Example

- Sulphur-limit of 0.5 % in ECA
- Price of MDO EURO 750.-/mt, price of HFO EURO 480.-/mt
- 3.5 % Sulphur in HFO, 0.1 % Sulphur in MDO
- Ratio = 88.2 % MOD / 11.8 % HFO

**Approximate saving potential: 5 - 10 % based on example.  
ROI will be between 3...12 months!**

## Recommended option Homogenizer

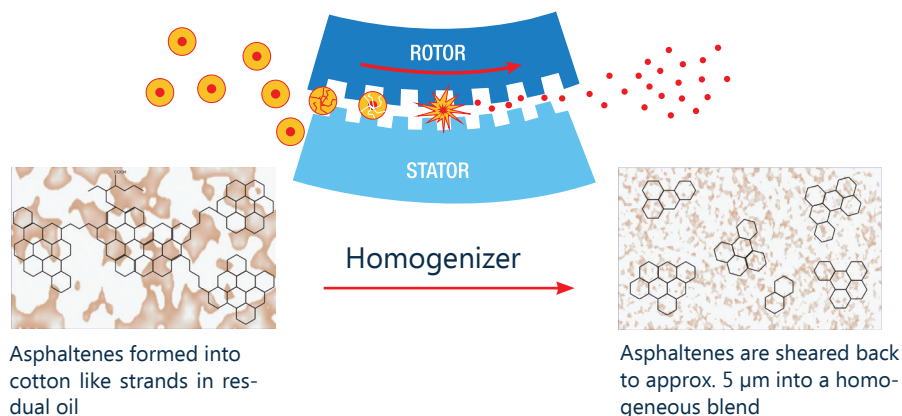

### Homgenizing of fuel oil and fuel oil blends

- Continuous HFO homogenizing on board
- Pure mechanical and no chemical treatment
- Improved combustion process
- Reduced exhaust emissions

## Specifications and ordering information

### DIESEL SWITCH

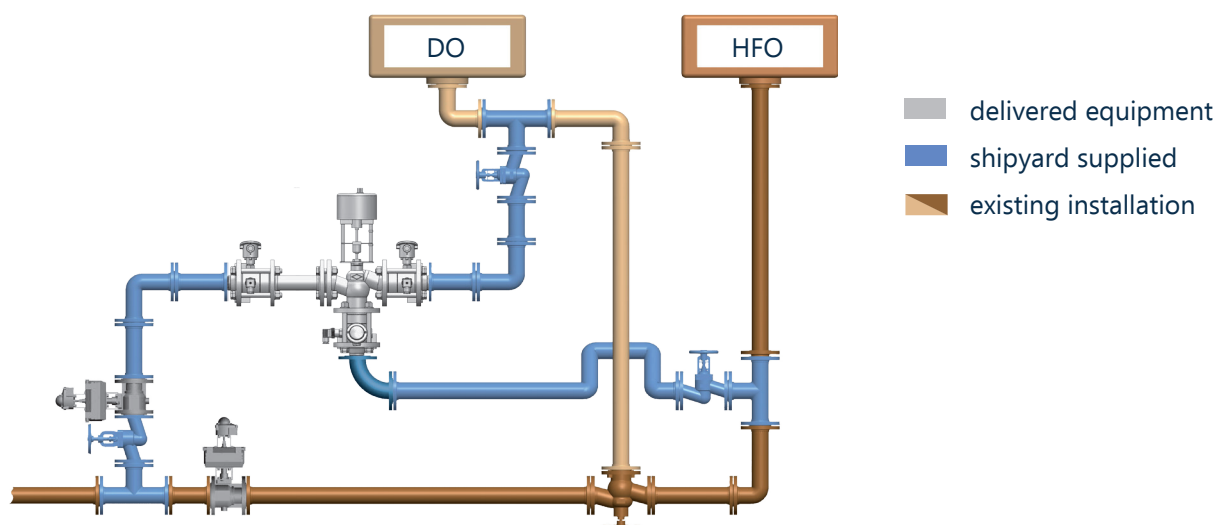

### Specification and ordering information

- Power supply: 230 VAC; 50/60 Hz; 80 W
- Air supply: 6 bar dry and clean air (for pneumatic shut off valve)

Size / Type	Flange connections	Art No.
DIESEL SWITCH DN32	DN32; PN16	94716
DIESEL SWITCH DN40	DN40; PN16	94717
DIESEL SWITCH DN50	DN50; PN16	94718
DIESEL SWITCH DN65	DN65; PN16	94719
DIESEL SWITCH DN80	DN80; PN16	94720

Options	Art No.
Fuel Compatibility Kit	94721
DS Ethernet cable	80824
Temperature transmitter T4.2 (DN32-50)	80782
Temperature transmitter T4.2 (DN65-80)	80786
Record Book	94722
Diesel Switch 2nd display 7"	95750
Diesel Switch GPS option	95190
Valve Position Switch Box V5	95306
Valve Position Relay Box V5	95317
Manual Shut off valves available	

Distributor in Hong Kong:

**Charles Marine Ltd**

Phone: 2463 6261  
 Email: [info@cmar.hk](mailto:info@cmar.hk)  
 URL: [www.cmar.hk](http://www.cmar.hk)

<b>SWITZERLAND:</b>	<b>Aquametro Oil &amp; Marine AG, CH-4106 Therwil</b>	<b>info@aquametro-oil-marine.com</b>	<b>www.aquametro-oil-marine.com</b>
<b>CHINA:</b>	Aquametro Oil & Marine (CHINA) PTE. LTD., Singapore 757516	info@aquametro-oil-marine.cn	www.aquametro-oil-marine.cn
<b>GERMANY:</b>	Aquametro Oil & Marine GmbH, D-18119 Rostock	info@aquametro-oil-marine.de	www.aquametro-oil-marine.de
<b>INDIA:</b>	Aquametro Oil & Marine Rep. Office, Mumbai 400053	info@aquametro-oil-marine.in	www.aquametro-oil-marine.in
<b>JAPAN:</b>	Aquametro Oil & Marine Rep. Office, Tokyo 152-0031	info@aquametro-oil-marine.jp	www.aquametro-oil-marine.jp
<b>KOREA:</b>	Aquametro Oil & Marine Korea LTD., Busan 612-857	info@aquametro-oil-marine.kr	www.aquametro-oil-marine.kr
<b>SINGAPORE:</b>	Aquametro Oil & Marine (S.E.A.) PTE. LTD., Singapore 757516	info@aquametro-oil-marine.sg	www.aquametro-oil-marine.sg
<b>UAE:</b>	Aquametro ME JLT, Dubai / UAE	info@aquametro-oil-marine.ae	www.aquametro-oil-marine.ae